

ARTICULO: 2233A

Válvula de Globo con extremos bridados ANSI 150 Globe Valve with flanged ends ANSI 150

Características

1. Válvula de Globo Clase 150.
2. Diseño según EN ISO 15761 (API 602).
3. Construcción en Acero Forjado ASTM A105.
4. Asiento inoxidable endurecido con Stellite.
5. Disco Inoxidable.
6. Trim # 8 (equivalente XU).
7. Extremos bridados según ANSI B 16.5.
8. Bonete atornillado.
9. Presión máxima de trabajo 19 bar.
10. Temperatura Máxima de trabajo: 420 °C.

Features

1. Globe valve 150 Class.
2. Design according to EN ISO 15761 (API 602).
3. Made by Forged Steel ASTM A105.
4. Stainless Steel Seat hardened with Stellite.
5. Stainless Steel Disc.
6. Trim # 8 (equivalent to XU).
7. Flanged ends according to ANSI B 16.5.
8. Bolted Bonnet.
9. Max. Working pressure 19 bar.
9. Max. Working temperature 420 °C.

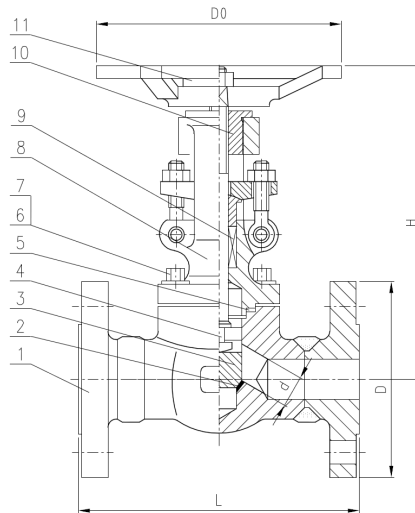

Nº	Denominación / Name	Material	Acabado Superficial / Surface Treatment
1	Cuerpo / Body	ASTM A105	Fosfatizado / Phosphatized
2	Asiento / Seat	Aporte de Stellite / Deposited STL.	-----
3	Disco / Disc	ASTM A182 F6a	-----
4	Eje / Stem	ASTM A276 - 410	-----
5	Junta Cuerpo / Body Gasket	S.S 304 + Graphite	-----
6	Tornillo tapa / Bonnet Bolt	ASTM A193 Gr. B7	-----
7	Tuerca tapa / Bonnet Nut	ASTM A194 Gr. 2H	-----

Nº	Denominación / Name	Material	Acabado Superficial / Surface Treatment
8	Estopada / Stem packing	Grafito / Graphite	-----
9	Prensa Estopa / Gland	ASTM A276 - 410	-----
10	Brida Prensa / Gland Flange	ASTM A105	Fosfatizado / Phosphatized
11	Tapa / Bonnet	ASTM A105	Fosfatizado / Phosphatized
12	Tuerca Eje / Stem Nut	ASTM A276 - 410	-----
13	Volante / Handwheel	Fundición / Cast Iron	Fosfatizado / Phosphatized

DIMENSIONES GENERALES / GENERAL DIMENSIONS

Ref	Medida / Size	Dimensiones / Dimensions (mm)					Peso / Weight (Kg)
		d	L	H	D0	D	
2233A 04	1/2"	10.5	108	185	80	90	3,400
2233A 05	3/4"	13	117	183	80	100	3,900
2233A 06	1"	16.5	127	218	105	110	5,950
2233A 07	1 1/4"	21.5	140	223	140	115	7,300
2233A 08	1 1/2"	27	165	245	140	125	10,500
2233A 09	2"	33	203	269	160	150	16,500

DIAGRAMA DE PERDIDAS DE CARGA / HEAD LOSSES DIAGRAM

(H₂O – 20 °C Flujo Horizontal / Horizontal flow).

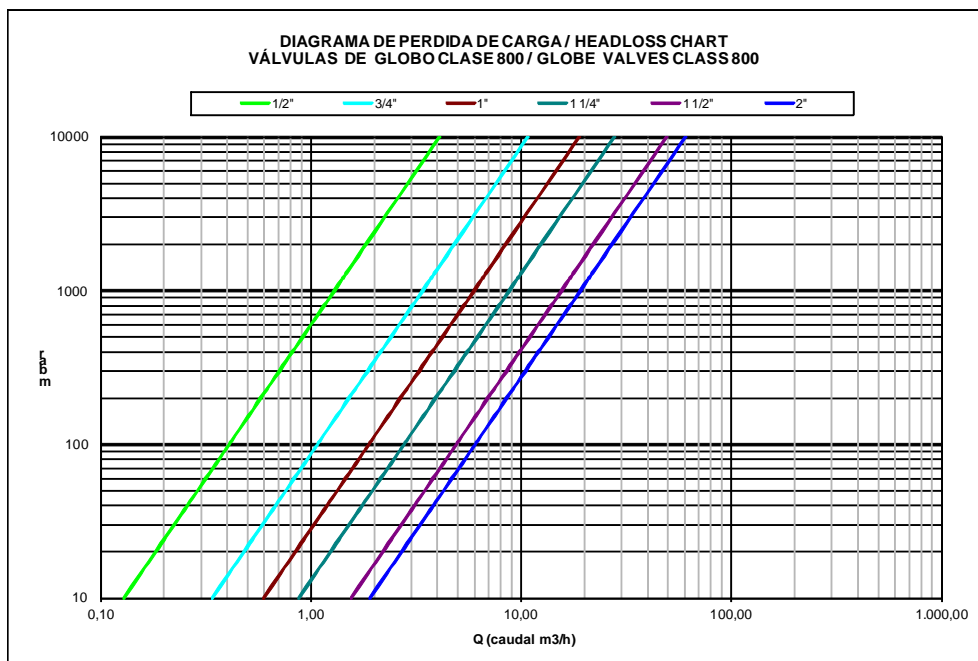

VALORES DE Kv / Kv VALUES

Kv = Es la cantidad de metros cúbicos por hora que pasará a través de la válvula generando una pérdida de carga de 1 bar.

Kv = The rate of flow of water in cubic meter per hour that will generate a pressure drop of 1 bar across the valve.

Med. /Size	1/2"	3/4"	1"	1 1/4"	1 1/2"	2"
m ³ /h	1.3	3.4	6	8.8	15.6	19.2

CURVA PRESION TEMPERATURA / PRESSURE TEMPERATURE RATING

